



# INFINITYLINK ILC274M/D



**SD-SDI, ASI Digital Video 4 Ch TDM Mux/Demux  
Installation and Operations Manual**





# **ILC274 Function Modules**

**SD-SDI, ASI Digital Video 4 Ch TDM Mux/Demux**

## **Installation and Operations Manual**

Document Number: AR200-006020-B00\_A  
Released: December, 2016





## **COPYRIGHT**

This manual is produced and copyrighted by Artel Video Systems Corporation. Any use or reproduction of the contents of this manual without the prior written consent of Artel Video Systems Corporation is strictly prohibited.

## **NOTICE**

All title and copyrights to this document are owned by Artel Video Systems Corporation. No part of the contents of this document may be reproduced or transmitted in any form or by any means without the written permission of Artel Video Systems Corporation.

Artel Video Systems Corporation shall not be liable for errors contained herein. Artel Video Systems Corporation shall not be liable for any damages whatsoever, including, without limitation, damages for loss of business profits, business interruption, loss of business information, or other pecuniary loss arising out of the use of this documentation even if Artel Video Systems Corporation has been made aware of the possibility of such damages.

Information contained in this document is subject to change without notice. While every effort is made to ensure that the information is accurate as of the publication date, users are reminded to update their use of this document with documents published by Artel Video Systems Corporation subsequent to this date. Updates may be available at [www.artel.com](http://www.artel.com) or by contacting Artel Video Systems Corporation.

Third-party product information is for informational purposes only, and constitutes neither an endorsement nor a recommendation. Artel Video Systems Corporation assumes no responsibility with regard to the performance of the third-party products.

Copyright © 2016 by Artel Video Systems Corporation  
ALL RIGHTS RESERVED  
Printed in U.S.A.

Artel Video Systems Corporation  
5B Lyberty Way  
Westford, MA 01886  
(978) 263-5775  
[www.artel.com](http://www.artel.com)

---

Revision history for the *ILC274 Function Modules Installation and Operations Manual*.

---

**Revision History**

<b>Revision</b>	<b>Document Number</b>	<b>Date</b>	<b>Reason for Change</b>
A	AR200-006020-B00_A	December, 2016	Initial release.



# Table of Contents

## About This Manual

Audience.....	ix
Related Documentation .....	ix
Symbols and Conventions.....	x
Artel Customer Service .....	x

## ILC274 Function Modules

Information About the ILC274 .....	1
ILC274 Laser Warnings .....	1
ILC274 Module Functional Descriptions .....	2
ILC274M Function Description.....	3
Signal Paths.....	3
Electrical Inputs .....	3
Optical Inputs and Outputs .....	4
ILC274D Functional Description.....	4
Signal Paths.....	5
Electrical Outputs.....	5
Optical Inputs and Outputs .....	5
Overview of the ILC274 Modules .....	6
ILC274M Overview .....	6
ILC274D Overview .....	8
Configuring the ILC274 Modules.....	10
Configuring the ILC274M.....	10
Configuring DIP Switch SW1 .....	11
Configuring DIP Switch SW3 .....	12
Configuring the ILC274D.....	13
Installing the ILC274 Modules and SFP .....	14
Cabling the ILC274 Modules .....	15
Cabling the Electrical Connections.....	15
Cabling the Optical Connections .....	15
Monitoring the ILC274 Module Operation .....	16
Monitoring the ILC274M Operations .....	16
Understanding the ILC274M Status LEDs .....	17
Using the ILC274M Monitor Jack .....	19
Monitoring the ILC274D Operations.....	19
Understanding the ILC274D Status LEDs.....	20
Using the ILC274D Monitor Jack.....	21
Removing the SFP and ILC274 Module .....	22
Removing the SFP.....	22
Removing the ILC274 Module .....	22

## Index







# About This Manual

This manual provides instructions for installing, configuring, and operating the ILC274 function module.

## Audience

This manual is intended for the following trained and qualified service personnel who are responsible for installing and operating the ILC274:

- System installer
- Hardware technician
- System operator

## Related Documentation

The following documentation contains material related to the ILC274 function module:

Document	Provides ...
<i>ILC274 Data Sheet</i>	Product operating and environmental specifications, and regulatory conformance information.
<i>ILC274 Quick Start</i>	Product configuration information and descriptions of the front panel status LED operations.
<i>InfinityLink IL6000 Chassis Installation and Operations Manual</i>	Overview installation instructions for the InfinityLink media transport platform chassis options, including the following: <ul style="list-style-type: none"><li>• IL6000 chassis—Installation of this 4-slot chassis, power supplies, and function modules.</li></ul>
<i>InfinityLink IL6000 Chassis Data Sheet</i>	Overview of the InfinityLink IL6000 chassis options.
<i>IL Manager Setup and Operations Manual</i>	Overview and operating instructions for the IL Manager element management system.

**Note:** To obtain the latest versions of this guide and the documents listed in this section, go to [www.artel.com](http://www.artel.com).

---

# Symbols and Conventions

This manual uses the following symbols and conventions.

## Caution

A caution means that a specific action you take or fail to take could cause harm to the equipment or to the data transmission.



## Warning

A warning describes an action you take or fail to take that could result in death, serious physical injury, or destruction of property.

**Note:** Important related information, reminders, and recommendations.

*Italics*—used for emphasis, for indicating the first occurrence of a new term, and for book titles

1. Numbered list—where the order of the items is important
  - Bulleted list—where the items are of equal importance and their order is unimportant

# Artel Customer Service

You can reach Customer Service by e-mail at [customer@artel.com](mailto:customer@artel.com) or by telephone:

In the US call (800) 225-0228, then select 1 for technical support.

Outside the US call (978) 263-5775, then select 1 for technical support.

When requesting assistance, please be ready to provide the following information:

- Your name and telephone number
- Product model and serial number
- Brief description of the problem
- List of symptoms
- Steps you have already taken to try to resolve the problem

### If the product is damaged

If any portion of the unit is damaged, forward an immediate request to the delivering carrier to perform an inspection of the product and to prepare a damage report. Save the container and all packing materials until the contents are verified.

Concurrently, report the nature and extent of the damage to Artel Customer Service so that action can be initiated to either repair or replace the damaged items.

Do not return any items to Artel until you obtain instructions from Customer Service.

Report the problem or deficiency to Customer Service along with the model number and serial number. Upon receipt of this information, Artel will provide service instructions, or a *Return Authorization Number* and shipping information.

# ILC274 Function Modules

## Overview and Installation

## Information About the ILC274

This manual introduces the ILC274 function module (ILC274), which is a two-module set consisting of the ILC274 multiplexer (ILC274M) and the ILC274 demultiplexer (ILC274D). The ILC274 utilizes Time Division Multiplexing (TDM) to transport four 270 Mb/s video signals on a single optical wavelength.

You can configure the host chassis with up to four ILC274 modules, enabling you to transport up to 16 circuits using a single rack unit. Featuring industry-standard Small Form Factor Pluggable (SFP) optics in 1310 nm, 1550 nm, CWDM, or DWDM wavelengths, up to 160 circuits can be transported over a single fiber. As with all Artel products, the ILC274 meets the stringent quality, safety, and reliability requirements of video service providers.

The ILC274 provides the following options for monitoring module operations:

- Switch-selectable front panel monitor of individual channels (using the mini 75 Ohm SMB)
- Front and rear panel status LEDs
- Video Present (individual channels) LEDs
- Loss of optical Input
- Laser (SFP) fail

Provisioning and monitoring is accomplished using DIP switches, LEDs, front panel monitor jack, or Artel's IL Manager, which is an element management system (for more information, see the *IL Manager Setup and Operations Guide*). The ILC274M and ILC274D modules also have a set of major and minor alarms for indicating problems related to the power supplies, optics, temperature, and input signals.

## ILC274 Laser Warnings

The SFP module used in the ILC274 has a transmitter that contains a Class 1 laser. You must adhere to the standard safety practices for handling a Class 1 laser product, including the following warning.



### Warning

**Never stare directly into a fiber optic connector.**

**Although the light used in most fiber optic transmissions is not visible to the naked eye, potentially harmful levels of radiation may be present at the optical output ports and unconnected transmit fiber ends.**

**Failure to observe this warning could result in personal injury.**



## ILC274 Module Functional Descriptions

This section provides a functional description of the ILC274 modules, which support the following 270 Mb/s formats video formats:

- SD-SDI (SMPTE 259M-C, ITU 656)
- SDTI (SMPTE 305M)
- DVB-ASI

Full clocking removes jitter from the SDI signals.

This section contains the following topics:

- [ILC274M Function Description \(page 3\)](#)
- [ILC274D Functional Description \(page 4\)](#)

## ILC274M Function Description

This sections provides a functional description of the ILC274M, including the functional block diagram shown in Figure 1.

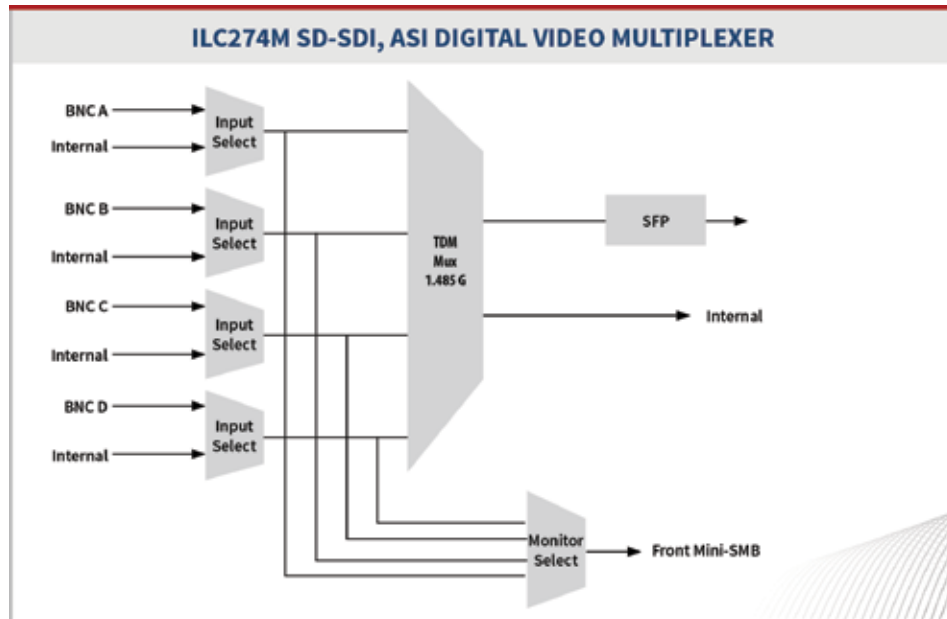

**Figure 1. ILC274M Module Functional Block Diagram**

This sections includes the following topics:

- [Signal Paths \(page 3\)](#)
- [Electrical Inputs \(page 3\)](#)
- [Optical Inputs and Outputs \(page 4\)](#)

### Signal Paths

The ILC274M takes four 270 Mb/s input video streams through channels A–D and multiplexes them into a single high-speed stream that it transmits onto an optical fiber. The four inputs can come from either the 75 Ohm BNC connectors on the rear panel of the ILC274M, or from another module in the IL6000 chassis. Each input video stream is checked for presence of the signal and for the correct frequency. A copy of each input video stream can be selected for monitoring at the front panel mini 75 Ohm SMB connector (see the [“Using the ILC274M Monitor Jack”](#) section on page 19). A copy of the high-speed stream is made available to other modules in the IL6000 chassis.

### Electrical Inputs

The electrical inputs of the ILC274M are precision 75 Ohm BNC connectors and include automatic cable equalization. This input passes through a reclocker that detects the signal rate but is format transparent. When no electrical input signal is connected, the ILC274M transmits a standby signal in the high-speed stream.

The front panel mini 75 Ohm SMB monitor jack (MON) also provides an electrical output. The signal on this connector is selected from any one of the four 270 Mb/s inputs to the ILC274M.

### Optical Inputs and Outputs

A single SFP socket provides the optical interface. The SFP modules use LC/PC connectors. Optical performance is dependent on the selected SFP. Consult Artel for available SFP options.

The SFP in the ILC274M is used for transmitting purposes only. The DIP switch configuration switch SW3 defaults the SFP receiver to off to prevent low light alarms (see the [“Configuring DIP Switch SW3”](#) section on page 12). SFP modules that cover the full spectrum (1310 nm, 1550 nm, CWDM, and DWDM) are available.

## ILC274D Functional Description

This section provides a functional description of the ILC274D, including the functional block diagram shown in [Figure 2](#).

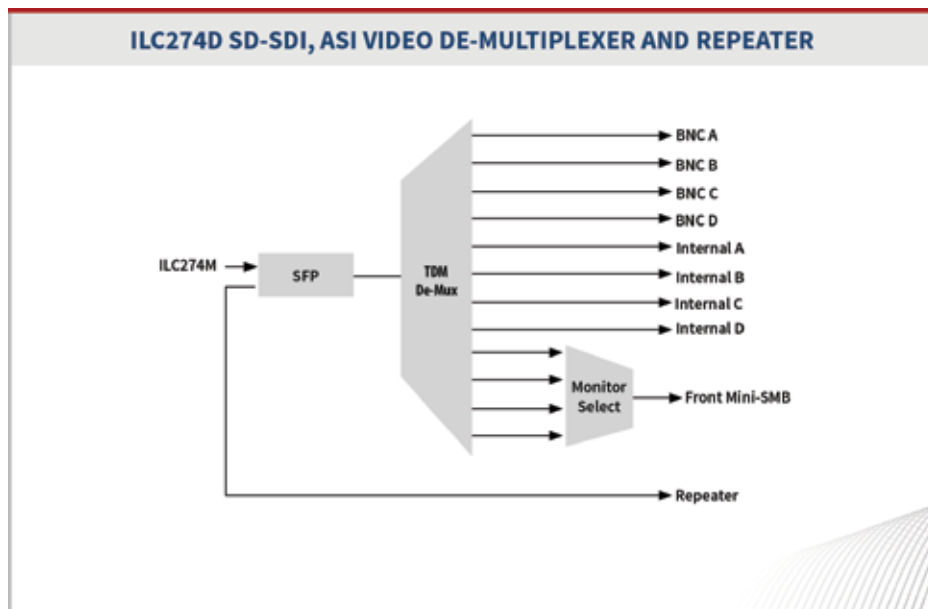

**Figure 2. ILC274D Module Functional Block Diagram**

This section contains the following topics:

- [Signal Paths \(page 5\)](#)
- [Electrical Outputs \(page 5\)](#)
- [Optical Inputs and Outputs \(page 5\)](#)

### **Signal Paths**

The ILC274D receives the high-speed optical stream, converts it to an electrical stream, and then demultiplexes the stream into the four original 270 Mb/s video streams.

Each of the resulting video streams are available at a 75 Ohm BNC connector on the rear panel of the ILC274D and are also available to other modules in the IL6000 chassis through the backplane. You can select each of the 270 Mb/s video streams for monitoring at the front panel mini 75 Ohm SMB monitor jack (see the [“Using the ILC274D Monitor Jack”](#) section on page 21).

Additionally, you can configure the ILC274D as a repeater to repeat/regenerate the received high-speed optical stream (optical-electrical-optical). For more information, see the [“Configuring the ILC274D”](#) section on page 13.

### **Electrical Outputs**

The electrical outputs of the ILC274D are precision 75 Ohm BNC connectors with a 270 Mb/s driver.

The front panel mini 75 Ohm SMB monitor jack (MON) also provides an electrical output. The user-selectable signals on this connector are the four 270 Mb/s video streams that the ILC274D demultiplexes from the high-speed optical stream.

### **Optical Inputs and Outputs**

A single SFP socket provides the optical interface. The SFP modules use LC/PC connectors. Optical performance is dependant the quality of your optical fiber and fiber interconnects, and on the selected SFP module, which must be specifically qualified by Artel to pass video signals. Consult Artel for available SFP options.

# Overview of the ILC274 Modules

This section provides an overview of the components that make up the ILC274M and ILC274D modules and contains the following topics:

- [ILC274M Overview \(page 6\)](#)
- [ILC274D Overview \(page 8\)](#)

## ILC274M Overview

Figure 3 provides a view of the major components of the ILC274M.

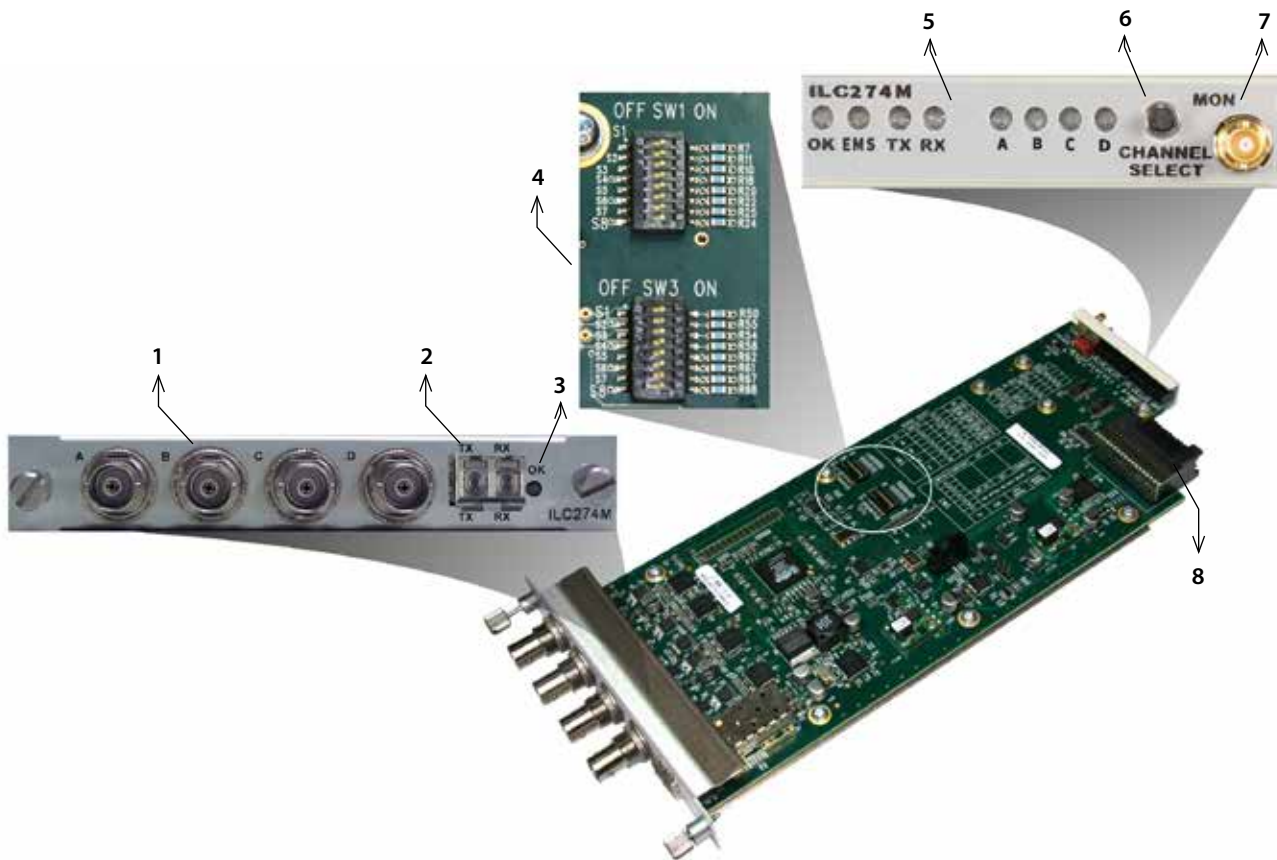

**Figure 3. ILC274M Module Major Components**

Table 1 describes the components called out in Figure 3.

**Table 1. ILC274M Elements**

Item	ILC274M Element	for details, see...
1	Four rear panel BNC connectors (A, B, C, D). Each connection accepts 270 Mb/s data.	<a href="#">Cabling the Electrical Connections (page 15)</a>

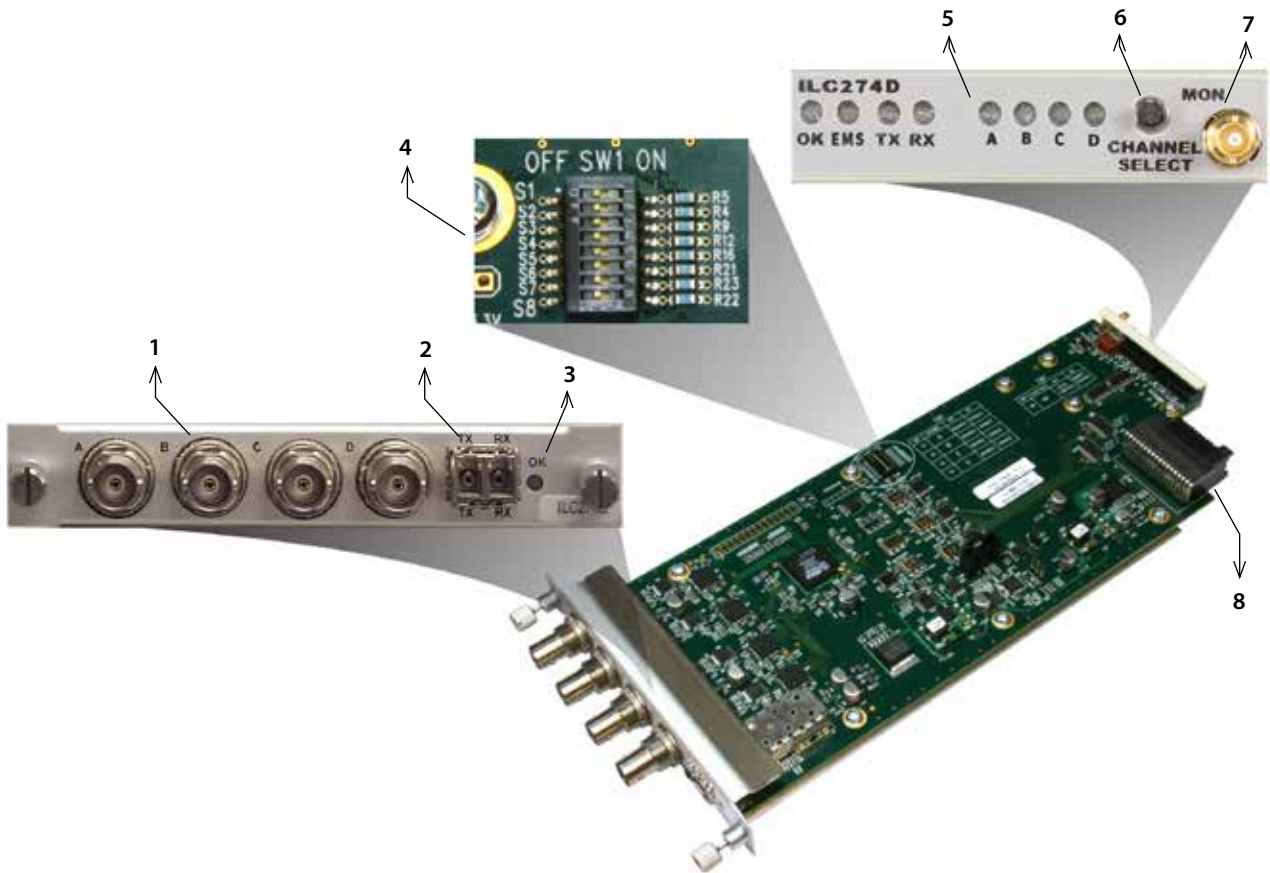

**Table 1. ILC274M Elements (Continued)**

Item	ILC274M Element	for details, see...
2	Rear panel SFP socket for the following optical connections: <ul style="list-style-type: none"> <li>• TX—Transmit</li> <li>• RX—Receive</li> </ul>	<a href="#">Cabling the Optical Connections (page 15)</a>
3	Rear panel alarm indicator LED (OK).	<a href="#">Monitoring the ILC274M Operations (page 16)</a>
4	Configuration DIP switches SW1 and SW3.	<a href="#">Configuring the ILC274M (page 10)</a>
5	Front panel status LEDs: <ul style="list-style-type: none"> <li>• OK—Alarm indicator</li> <li>• EMS—Element Management System indicator</li> <li>• TX—Transmit signal indicator</li> <li>• RX—Receive signal indicator</li> <li>• A, B, C, D—Channel status indicators</li> </ul>	<a href="#">Monitoring the ILC274M Operations (page 16)</a>
6	Front panel monitor Channel Select switch.	<a href="#">Using the ILC274M Monitor Jack (page 19)</a>
7	Front panel monitor mini 75 Ohm SMB output jack (MON).	
8	Backplane connector—Provides power to the module, allows the module to share signals with other function modules, and is used for alarm and management signals.	N/A

## ILC274D Overview

Figure 4 provides a view of the major components of the ILC274D.



**Figure 4. ILC274D Module Major Components**

Table 2 describes the components called out in Figure 4.

**Table 2. ILC274D Elements**

Item	ILC274D Element	for details, see...
1	Four rear panel BNC connectors (A, B, C, D) for electrical connections.	<a href="#">Cabling the Electrical Connections (page 15)</a>
2	Rear panel SFP socket for the following optical connections: <ul style="list-style-type: none"> <li>• TX—Transmit</li> <li>• RX—Receive</li> </ul>	<a href="#">Cabling the Optical Connections (page 15)</a>
3	Rear panel alarm indicator LED (OK).	<a href="#">Monitoring the ILC274D Operations (page 19)</a>
4	Configuration DIP switch SW1	<a href="#">Configuring the ILC274D (page 13)</a>

**Table 2. ILC274D Elements (Continued)**

Item	ILC274D Element	for details, see...
5	Front panel status LEDs: <ul style="list-style-type: none"> <li>• OK—Alarm indicator</li> <li>• EMS—Element management system (IL Manager) indicator</li> <li>• TX—Transmit signal indicator</li> <li>• RX—Receive signal indicator</li> <li>• A, B, C, D—Channel status indicators</li> </ul>	<a href="#">Monitoring the ILC274D Operations (page 19)</a>
6	Front panel monitor Channel Select switch.	<a href="#">Using the ILC274D Monitor Jack (page 21)</a>
7	Front panel monitor mini 75 Ohm SMB output jack (MON).	
8	Backplane connector—Provides power to the module, allows the module to share signals with other function modules, and is used for alarm and management signals.	N/A

# Configuring the ILC274 Modules

This section describes how to configure the operation of the ILC274M and ILC274D modules. You must configure the modules while they are out of the IL6000 chassis because the configuration DIP switches are mounted to the top of the module PCBs.

This section contains the following topics:

- [Configuring the ILC274M \(page 10\)](#)
- [Configuring the ILC274D \(page 13\)](#)

## Configuring the ILC274M

DIP switches SW1 and SW3, located on top of the PCB (see [Figure 3](#) for switch locations), determine the operating configuration of the ILC274M.

Switch SW1 controls the channel (A, B, C and D) operation including disabling the time slot and selecting the signal source (BNC versus backplane (BP)).

Switch SW3 controls the operation of the optical SFP module including enabling the optical receiver and limiting its signal rates.

Artel ships the ILC274M configured as follows:

- All four channels enabled
- BNC connector selected as the source for each channel
- Optical transmit (TX) enabled
- Optical receive (RX) disabled
- No video detected alarm disabled
- EMS override enabled (IL Manager can change the ILC274M configuration)

This section contains the following topics:

- [Configuring DIP Switch SW1 \(page 11\)](#)
- [Configuring DIP Switch SW3 \(page 12\)](#)

### Configuring DIP Switch SW1

Switch SW1 controls the channel (A, B, C and D) operation including disabling the time slot and selecting the signal source (BNC versus backplane (BP)). Figure 5 shows the ILC274M configuration switch SW1 located on top of the PCB.



**Figure 5. ILC274M Configuration Switch SW1**

Table 3 describes the DIP switch SW1 configuration options. The factory-set configuration settings are shown in bold type.

**Table 3. DIP Switch SW1 Settings**

Position	Function	Switch Setting	
		OFF	ON
S1	CH A ON	Disables Channel A timeslot	<b>Normal channel A operation</b>
S2	CH A BNC	Selects Slot 1 backplane source	<b>Channel A BNC input</b>
S3	CH B ON	Disables Channel B timeslot	<b>Normal channel B operation</b>
S4	CH B BNC	Selects Slot 2 backplane source	<b>Channel B BNC input</b>
S5	CH C ON	Disables Channel C timeslot	<b>Normal channel C operation</b>
S6	CH C BNC	Selects Slot 3 backplane source	<b>Channel C BNC input</b>
S7	CH D ON	Disables Channel D timeslot	<b>Normal channel D operation</b>
S8	CH D BNC	Selects Slot 4 backplane source	<b>Channel D BNC input</b>

When a video SFP is installed, you can enable the optical receiver and use it as a signal input to the ILC274M. The ILC274M receiver signal is only available to the ILC274M as a backplane source for the slot in which it is installed. It is not available to other modules in the chassis.

To use the optical receiver as the input, set the ILC274M channel that coincides with the slot in which the ILC274M is installed to the backplane source setting (set the switch to OFF). For example, if the ILC274M is installed in Slot 1, enable Channel A to receive the optical receiver input signal from the backplane by setting SW1, S2 to OFF.

To bring up to four optical 270 Mb/s signals into a single IL6000 chassis and combine them into a single wavelength, use three ILC103A modules plus the ILC274M SFP receiver (see [Figure 1](#)). On the ILC274M, set the SW1 switches for each of the four channels to OFF to select the backplane source. You can install the ILC274M into any slot on the IL6000. The optical signal received in slot 1 will be transmitted as Channel A, slot 2 as Channel B, and so on.

### Configuring DIP Switch SW3

Switch SW3 controls the operation of the optical SFP module including enabling the optical receiver and limiting its signal rates. This switch also controls the video alarm operation that enables the ILC274M to produce a major alarm when it cannot detect a video signal or when it detects an incorrect video rate. For more information related to this alarm function, see LEDs A, B, C, D in [Table 6](#).

[Figure 6](#) shows the ILC274M configuration switch SW1 located on top of the PCB.



**Figure 6. ILC274M Configuration Switch SW3**

[Table 4](#) describes the DIP switch SW3 configuration options. The factory-set configuration settings are shown in bold type.

**Table 4. DIP Switch SW3 Settings**

Position	Function	Switch Setting	
		OFF	ON
S1	Video Alarm Disable	Alarm on video loss	<b>No alarm on video loss</b>
S2	Reserved		<b>Must be ON</b>
S3	Reserved		<b>Must be ON</b>
S4	Optical TX Enable	Optical TX disabled	<b>Optical TX enabled</b>
S5	Optical RX Disable	Optical RX enabled	<b>Optical RX disabled</b>
S6	Reserved		<b>Must be ON</b>
S7	Reserved		<b>Must be ON</b>
S8	EMS override	Disabled: IL Manager cannot change the ILC274M module configuration. <sup>1</sup>	<b>Enabled:</b> IL Manager can change the ILC274M module configuration.

1. If the module is operating in EMS Override mode, as indicated by a green EMS LED on the front panel, then the EMS Override DIP switch has no effect until you use IL Manager to take the module out of Software Mode and set it to Hardware Mode (see the *IL Manager Setup and Operations Guide*).

## Configuring the ILC274D

DIP switch SW1 (see [Figure 7](#)), located on top of the PCB, determine the operating configuration of the ILC274D, including the video alarm operation, which enables the ILC274D to produce a major alarm when it cannot detect a video signal or when it detects an incorrect video rate. For more information related to this alarm function, see LEDs A, B, C, D in [Table 7](#).



**Figure 7. ILC274D Configuration Switch SW1**

Artel ships the ILC274D configured as follows:

- All four channels enabled
- No video detected alarm disabled
- EMS override enabled (IL Manager can change the ILC274D configuration)

[Table 5](#) describes the DIP switch SW1 configuration options. The factory-set configuration settings are shown in bold type.

**Table 5. DIP Switch SW1 Settings**

Position	Function	Switch Setting	
		OFF	ON
S1	Channel A Operation	Disables output.	<b>Normal operation.</b>
S2	Channel B Operation	Disables output.	<b>Normal operation.</b>
S3	Channel C Operation	Disables output.	<b>Normal operation.</b>
S4	Channel D Operation	Disables output.	<b>Normal operation.</b>
S5	Optical TX Disable	Repeater operation.	Disables transmitter/repeater.
S6	Video Alarm Disable	Alarm on video loss	<b>No alarm on video loss</b>
S7	Reserved		<b>Must be ON</b>
S8	EMS override	Disabled: IL Manager cannot change the ILC274D module configuration. <sup>1</sup>	<b>Enabled:</b> IL Manager can change the ILC274D module configuration.

1. If the module is operating in EMS Override mode, as indicated by a green EMS LED on the front panel, then the EMS Override DIP switch has no effect until you use IL Manager to take the module out of Software Mode and set it to Hardware Mode (see the *IL Manager Setup and Operations Guide*).

# Installing the ILC274 Modules and SFP

The ILC274 and associated SFP are hot swappable, enabling you to safely install them while power is applied to the IL6000. Before you install the ILC274, see the ILC274 Multiplexer/De-multiplexer data sheet for a detailed description of the ILC274 product specifications including environmental requirements that you must adhere to when installing the modules.

To install a ILC274 in the IL6000 chassis (see [Figure 8](#)), perform the following steps:

1. From the back of the IL6000 chassis, remove the two screws that secure the blank tray to one of the unused function module slots (if necessary). Use any available function module slot.
2. Slide the ILC274 into the slot using the printed circuit board guide rails located on both sides of the slot.
3. Push the ILC274 in until it is firmly seated into the backplane and flush with the chassis.
4. Tighten the two mounting screws that secure the module to the chassis.

**Note:** Failure to properly secure the ILC274 to the chassis with the two mounting screws can result in disconnecting the module from the backplane when you attach a cable to the monitor connector located on the front panel.

5. Install the SFP into the ILC274 (handle on top as shown in [Figure 8](#)). Push the SFP into the socket located on the right side of the function module until it is firmly seated into the socket.

**Note:** When you do not install an SFP, the TX and RX status LEDs located on the ILC274 front panel both flash. See [Table 6](#) for other LED status indications.

6. Repeat this procedure for each ILC274 module that you are installing in the IL6000 chassis.

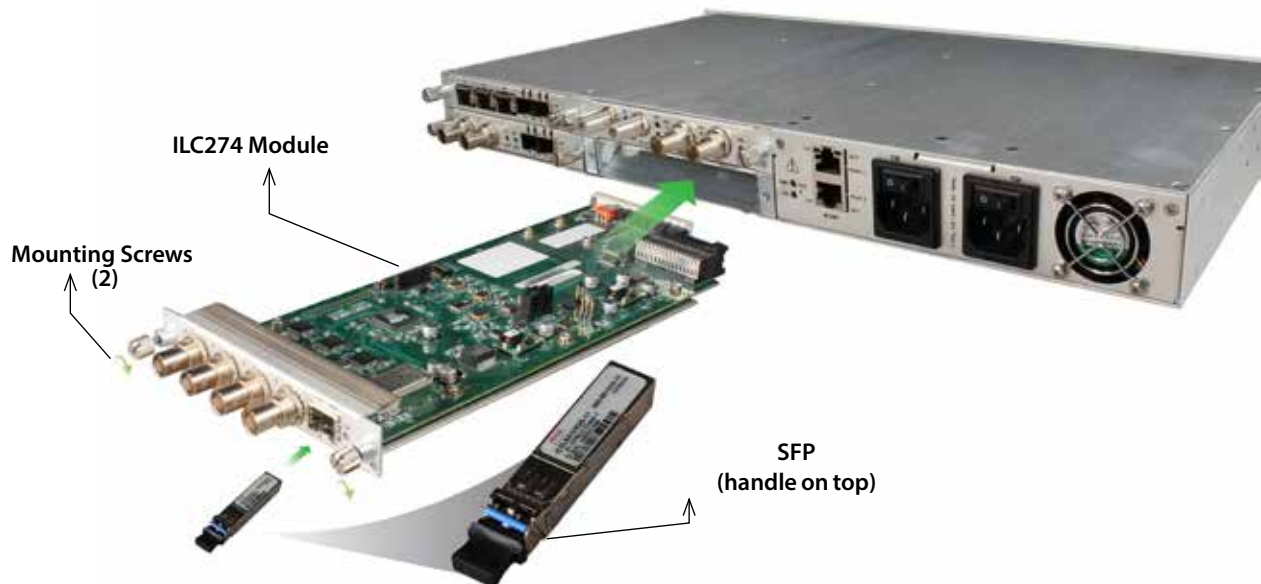

**Figure 8.** ILC274 Module and SFP Installation

**Note:** Insert a blank tray in any unused chassis module slots to maintain proper ventilation.



# Cabling the ILC274 Modules

The ILC274 allows you to transmit and receive signals over electrical and fiber optic cable connections. The cabling configuration that you use depends on your application. You can have electrical in and out, optical in and out, or any combination of the two. The electrical and optical connectors are located on the rear panel of the ILC274 (see [Figure 9](#)). You can access the connectors from the rear panel of the IL6000 chassis.

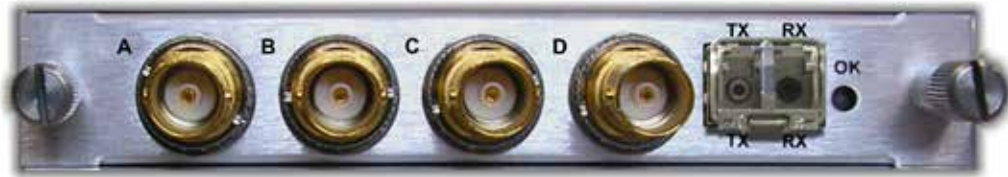

**Figure 9.** ILC274 BNC Electrical Connectors and SFP Optical Connectors

**Note:** When handling fiber optic cables, adhere to the standard safety practices for handling a Class 1 laser product (see [“ILC274 Laser Warnings”](#) section on page 1).

This section contains the following topics:

- [Cabling the Electrical Connections](#) (page 15)
- [Cabling the Optical Connections](#) (page 15)

## Cabling the Electrical Connections

To connect to the BNC connectors on the ILC274, use a high quality 75 Ohm precision video coax cable, such as Belden 1694A cable.

## Cabling the Optical Connections

Use a single mode fiber when connecting to the LC connectors of the ILC274 SFP.

To cable the optical connections, perform the following tasks:

1. Remove the SFP safety plug that protects the TX and RX ports. Cover any unused optical port to keep the port clean.
2. Cable the optical connections as follows:
  - Receive signal—Connect the fiber optic cable to the source device’s optical transmit connector and the SFP receive optical connector (RX) on the ILC274.
  - Transmit signal—Connect the fiber optic cable to the destination device’s optical receive connector and the SFP transmit optical connector (TX) on the ILC274.

# Monitoring the ILC274 Module Operation

You monitor the operation of the ILC274 using the status LEDs and monitor port located on the front panel of the modules. The front panel of an installed ILC274 is viewed from the front panel of the IL6000 chassis as shown in [Figure 10](#).

**Note:** You can also use Artel's element management system, IL Manager, to remotely manage and monitor the module operations.

This section contains the following topics:

- [Monitoring the ILC274M Operations \(page 16\)](#)
- [Monitoring the ILC274D Operations \(page 19\)](#)

## Monitoring the ILC274M Operations

This section describes how to monitor the ILC274M operations using the front panel LEDs and the monitor (see [Figure 10](#)).

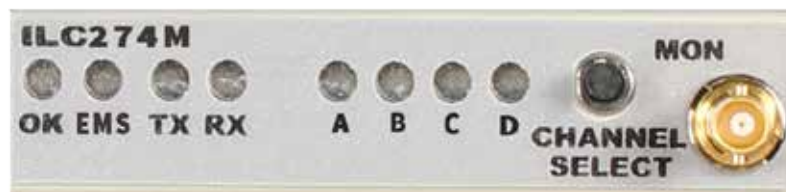

**Figure 10.** ILC274M Status LEDs and Monitor Connector

This section contains the following topics:

- [Understanding the ILC274M Status LEDs \(page 17\)](#)
- [Using the ILC274M Monitor Jack \(page 19\)](#)

## Understanding the ILC274M Status LEDs

Table 6 describes the different states of the ILC274M status LEDs as shown in Figure 10.

**Table 6. ILC274M Status LEDs**

LED	Indicates . . .	State	Description	Alarms	Action
OK (also located on the rear panel (see Figure 9))	The ILC274M status	Off	If power is applied to the system, an internal fault with the ILC274M may exist.	None	Replace the ILC274M.
		Green	Normal operation.	None	Check other Status LEDs.
		Yellow	If no other status LEDs indicate a minor alarm, then a temperature alarm is indicated.	Minor	Check for adequate inlet and exhaust airflow.
		Red	If no other status LEDs indicate a major alarm, then an internal error is indicated, such as an onboard communications error or an onboard power error.	Major	Replace the ILC274M.
EMS	Element management system, IL Manager, operating status	Off	The ILC274M module is in local mode and its configuration is controlled by the onboard configuration switches.	None	None.
		Green	The ILC274M module is in remote mode and the configuration has been set by IL Manager. When in remote mode, the actual configuration of the module will likely not match the settings of the configuration switches and changing the configuration switches will have no effect on the module operation.	None	None.
TX	Transmitter status	Off	Transmitter is disabled.	None	None.
		Green	Normal operation.	None	None.
		Red (solid)	SFP TX failure exists.	Major	Replace the SFP.
		Red (flashing)	No SFP is installed.	Major	Install an SFP or replace the existing SFP.
RX	Receiver status	Off	Receiver is disabled.	None	None.

**Table 6. ILC274M Status LEDs (Continued)**

LED	Indicates ...	State	Description	Alarms	Action
A, B, C, D	270 Mb/s channel status	Off	Input disabled.	None	Check SW1 configuration (see <a href="#">Table 4</a> ).
		Green	270 Mb/s video detected.	None	None.
		Yellow	No signal applied.	None or Major*	Check input signal.
		Red	Video input signal rate is outside the range (270 Mb +/- 100 ppm)	None or Major*	Check input signal.

\* You must have SW3, S1 set to OFF for the ILC274M to report a major alarm condition when this video signal state exists (see ["Configuring the ILC274M"](#) section on page 10).

### Using the ILC274M Monitor Jack

To monitor the ILC274M transmit and receive signals, perform the following steps:

1. Connect the monitor cable to the mini 75 Ohm SMB monitor jack (MON) located on the ILC274 front panel (see [Figure 10](#)).
2. Select the desired channel using the monitor select switch. When you press the switch once, the display changes from channel status display to monitor selection display, indicated by the selected channel flashing while the others are off. If you do not press the switch again, the display reverts back to channel status after approximately 5 seconds. Each time you press the switch while the selected channel is flashing, the selected channel will sequence through A->B, B->C, C->D, and then D back to A. When the module is powered on, it briefly displays the last selected channel.

### Monitoring the ILC274D Operations

This section describes how to monitor the ILC274D operations using the front panel LEDs and the monitor (see [Figure 11](#)).



**Figure 11.** ILC274D Status LEDs and Monitor Connector

This section contains the following topics:

- [Understanding the ILC274D Status LEDs \(page 20\)](#)
- [Using the ILC274D Monitor Jack \(page 21\)](#)

## Understanding the ILC274D Status LEDs

Table 7 describes the different states of the ILC274D status LEDs as shown in Figure 11.

**Table 7. ILC274D Status LEDs**

LED	Indicates . . .	State	Description	Alarms	Action
OK (also located on the rear panel (see Figure 9))	The ILC274D status	Off	If power is applied to the system, an internal fault with the ILC274D may exist.	None	Replace the ILC274D.
		Green	Normal operation.	None	None.
		Yellow	If no other status LEDs indicate a minor alarm, then a temperature alarm is indicated.	Minor	Check that there is adequate inlet and exhaust airflow.
		Red	If no other status LEDs indicate a major alarm, then an internal error is indicated, such as an onboard communications error or onboard power error.	Major	Replace the ILC274D.
EMS	Element Management System status	Off	The ILC274D module is in local mode and its configuration is controlled by the onboard configuration switches.	None	None.
		Green	The ILC274D module is in remote mode and the configuration has been set by the EMS. When in remote mode, the actual configuration of the module will likely not match the settings of the configuration switches and changing the configuration switches will have no effect on the module operation.	None	None.
TX	Transmitter status	Off	Transmitter is disabled.	None	None.
		Green	Normal operation (repeating input signal).	None	None.
		Red (solid)	SFP TX failure exists.	Major	Replace the SFP.
		Red (flashing)	No SFP is installed.	Major	Install an SFP or replace the existing SFP.

**Table 7. ILC274D Status LEDs (Continued)**

LED	Indicates ...	State	Description	Alarms	Action
RX	Receiver status	Green	Normal operation.	None	None.
		Yellow	Link errors detected.	Minor	Check the optical link.
		Yellow (flashing)	Receive optical power is high.	Minor	Check the optical link.
		Red (solid)	No input signal or the input signal type is incorrect (not a valid ILC274M signal).	Major	Check the optical link or the input source.
		Red (flashing)	Possible causes: <ul style="list-style-type: none"> <li>• A low receiver input power condition exists.</li> <li>• No SFP is installed.</li> <li>• An SFP RX failure exists.</li> </ul>	Major	Check the received optical power, install the missing SFP, or replace the existing SFP.
A, B, C, D	270 Mb/s channel status	Off	Channel is disabled on the ILC274D or ILC274M.	None	Check the DIP switch configurations on both devices.
		Green	270 Mb/s video detected.	None	None.
		Yellow	No input signal to the ILC274M	None or Major*	Check the ILC274M input signal.
		Red	Video input signal rate is outside the range (270 Mb +/- 100 ppm)	None or Major*	Check the ILC274M input signal.

\*You must have SW1, S6 set to OFF for the ILC274D to report a major alarm condition when this video signal state exists (see [“Configuring the ILC274D”](#) section on page 13).

### Using the ILC274D Monitor Jack

To monitor the ILC274D transmit and receive signals, perform the following steps:

1. Connect the monitor cable to the mini 75 Ohm SMB monitor jack (MON) located on the ILC274D front panel (see [Figure 11](#)).
2. Select the desired channel using the monitor select switch. When you press the switch once, the display changes from channel status display to monitor selection display, indicated by the selected channel flashing while the others are off. If you do not press the switch again, the display reverts back to channel status after approximately 5 seconds. Each time you press the switch while the selected channel is flashing, the selected channel will sequence through A->B, B->C, C->D, and then D back to A. When the module is powered on, it briefly displays the last selected channel.

# Removing the SFP and ILC274 Module

You can safely remove either the SFP from the ILC274 or the ILC274 from the chassis while power is applied to the module.

This section contains the following topics:

- [Removing the SFP \(page 22\)](#)
- [Removing the ILC274 Module \(page 22\)](#)

## Removing the SFP

To remove the SFP from the ILC274 (see [Figure 12](#)), perform the following steps:

1. Remove the fiber optic cables from the SFP.
2. Pull down on the SFP handle to dislodge the SFP from the ILC274.
3. Using the SFP handle, pull the SFP out of the ILC274.



**Figure 12. Removing the SFP**

## Removing the ILC274 Module

To remove the ILC274 from the chassis, perform the following steps:

1. Remove the fiber optic cables from the ILC274 module SFP.
2. Remove the coaxial cables from the BNC connectors.
3. Loosen the two mounting screws that secure the ILC274 to the chassis.
4. Using the two mounting screws, pull the ILC274 out of the chassis.

### Caution

To avoid problems associated with overheating, do not leave a function module slot open when power is applied to the chassis. Every module slot must contain a module or blank tray to ensure proper ventilation when power is applied.



## A

audience [ix](#)

## C

cable interfaces [15](#)  
caution definition [x](#)  
configure operations  
    ILC274D [13](#)  
    ILC274M [10](#)  
conventions [x](#)  
Customer Service [x](#)

## E

e-mail address, Customer Service [x](#)

## F

functional description [2](#)

## L

LEDs, status  
    ILC274D [20](#)  
    ILC274M [17](#)

## M

module  
    cable [15](#)  
    components  
        ILC274D [8](#)  
        ILC274M [6](#)  
    configure  
        ILC274D [13](#)  
        ILC274M [10](#)  
    install [14](#)  
    monitor  
        ILC274D [19](#)  
        ILC274M [16](#)

## O

overview, components  
    ILC274D [8](#)  
    ILC274M [6](#)

## R

related documentation [ix](#)  
return authorization (RA) number [x](#)

## S

shipment, damaged [x](#)  
status LEDs  
    ILC274D [19, 20](#)  
    ILC274M [16, 17](#)  
SW1  
    ILC274D [13](#)  
    ILC274M [11](#)  
SW3, ILC274M [12](#)  
symbols [x](#)

## W

warning definition [x](#)





## Proven Products, Unrivaled Service, and Great Support



- Proven technology in a rugged, reliable package
- Supports all formats across all networks
- Intuitive and simplified user interfaces
- Integrated, modular, and flexible
- Compact and low power
- Off-the-shelf delivery
- Network requirements analysis and design services
- Training and installation support available
- 24x7x365 technical support available



Artel Video Systems Corp.  
5B Lyberty Way, Westford, MA 01886 USA  
T: 978-263-5775 | F: 978-263-9755 | [www.artel.com](http://www.artel.com)  
Domestic Sales: [sales@artel.com](mailto:sales@artel.com)  
International Sales: [internationalsales@artel.com](mailto:internationalsales@artel.com)  
Technical Support: [customercare@artel.com](mailto:customercare@artel.com)

Content subject to change without notice.  
©2016